

# LOW PROFILE FEEDER™

INNOVATIVE HYBRID FEEDER TECHNOLOGY FOR ALL BULK INTAKE OR IN-PROCESS APPLICATIONS



AUSTRALIAN PATENTED TECHNOLOGY  
No. AU 2010200824 B2

# AUSTRALIAN ENGINEERING WORLDWIDE

**Transmin is a world-class provider of innovative engineered equipment, supplies and services to the resources and bulk materials handling industries.**

Established in Perth, Western Australia in 1987, Transmin sets the standard for mechanical equipment design and application, led by our specialist Engineering division, and backed by our dedicated Aftermarket division. Transmin's Control and Automation division delivers award-winning software solutions specialising in remote equipment operation and systems integrations.

The Transmin equipment range covers most bulk materials-handling applications, including; feeders and conveyors, bulk loading and unloading hoppers, rock-breakers, hydraulic boom systems, bin isolation gates, reagent preparation and processing facilities, lime preparation facilities, ball charging systems and silos.



-  Transmin Head Office
-  Transmin Offices/Agencies
-  Countries in which Transmin equipment is deployed





# TRUE INNOVATIVE THINKING



AUSTRALIAN PATENTED TECHNOLOGY  
No. AU 2010200824 B2

**Transmin's Low Profile Feeder™ (LPF) is the original hybrid feeder delivering the advantages of both belt and apron feeders, plus additional benefits over conventional feeder technology that are unique to Transmin.**

LPF capacities vary according to application, although rates of 10,000tph are possible. The LPF is built with trusted components, proven in the most arduous applications and with a low ongoing cost of ownership.

The LPF has the unique ability to incorporate a bend transition, which means a change of direction from horizontal to 25° inclined can be achieved without the requirement of a second machine; resulting in improved space utilisation, flexibility of plant layout and elimination of transfer points between conveyors, thereby reducing civil costs.

## TYPICAL INDUSTRIES

- ▶ Mining and mineral processing
- ▶ Ports
- ▶ Cement and building products
- ▶ Recycling and waste processing
- ▶ Power generation
- ▶ Fertiliser and chemical

## MATERIALS

- ▶ Various ores
- ▶ Iron ore, tailings and stockpiled ores
- ▶ Coal
- ▶ Fertilisers
- ▶ Metallic concentrates
- ▶ Filter cakes
- ▶ Wood chips
- ▶ Cement clinker
- ▶ Sewage sludge
- ▶ Refuse
- ▶ Biomass
- ▶ Construction wastes
- ▶ Aggregate

## BENEFITS OF THE LPF

- ▶ Elimination of belt tracking issues
- ▶ Elevated discharge can be achieved by the introduction of a bend transition
- ▶ Reversing capability
- ▶ Space saving
- ▶ Elimination of belt slippage
- ▶ Minimal product spillage
- ▶ Simple modular sections for belt change out
- ▶ Conventional belt cleaners for ease of cleaning
- ▶ Proven industry standard components

**“In fairness, the machine was used above and beyond its initial design spec and it's never missed a beat. This thing is bullet proof.”**

**STUART TAYLOR, Karara Project**



# A REVOLUTION IN FEEDER TECHNOLOGY



## Reversible Feeding



Transmin is the market leader in hybrid feeder technology. The Low Profile Feeder has become the industry benchmark through a process of continued improvement and product development.

- ▶ Lengths up to 56m
- ▶ Incline angles up to 25°
- ▶ Belt widths up to 4.0m
- ▶ Weighing of material in transit
- ▶ One sided belt fastening
- ▶ Reversing capability for discharge at both ends
- ▶ Numerous installations around the world





**Less Spillage**

**Mistracking Eliminated**

**Belt Slippage Eliminated**

**Lowest Possible Profile**



FEATURES	TRANSMIN LPF™	CONVENTIONAL BELT FEEDER	APRON FEEDER
Space occupied within the plant	✔ Minimal - e.g. 3.0m wide belt, 4000tph iron ore = 1.0m vertical height	✘ Can be substantial when high belt tensions present due to large head pulley diameters	✘ Can be substantial, especially when spillage conveyors are required
Belt tracking	✔ No adjustments necessary	✘ Belts can mis-track and require adjustment	✔ No adjustments necessary
Belt slippage	✔ Eliminated	✘ Belt can slip	✔ N/A - no slip
Product spillage	✔ Minimal	✔ Minimal	✘ Pan leakage
Requirement for spillage conveyors	✔ Not required	✔ Not required	✘ Frequently required
Ease of cleaning	✔ Conventional belt cleaners	✔ Full width conventional belt cleaners	✘ Can be difficult to clean effectively
Belt change out	✔ Simple modular sections	✘ Belt splicing station required	✔ N/A
Elevated discharge	✔ Can change direction by the introduction of a bend	✘ Limited to horizontal or inclined only	✘ Limited to horizontal or inclined only
Suitability for ROM Dump Applications	✔ Consult Transmin	✘ Generally not suitable	✔ Proven for large run of mine dump applications

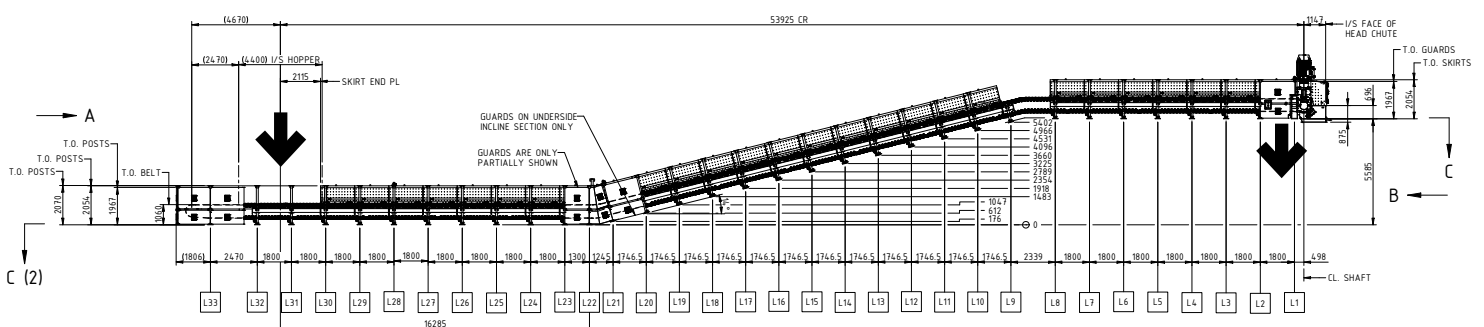

Iron Ore 2,700tph x 55m long





# FEATURES



**Flow Control Gates**  
Fixed or adjustable



**ProEdge**  
Hot vulcanised belt edge



**KwiksertPro**  
One sided belt fastening



**Elevated discharge capability**



**Wear liners to suit material being handled**



**Conventional belt cleaners are used**



**Various drive styles**



**Belt protection bars for sharp or lumpy materials**



**In process weighing**



**Various bearing lubrication options**



**Cross slats support the belt**



**Optional weather enclosure**



## FULL RANGE FROM LIGHT TO HEAVY DUTY



### Round Link Chain - RL Series

- ▶ Light to medium duties
- ▶ Standard round link chain
- ▶ Segmented or individual toothed sprockets
- ▶ No pins, bushes or bearings
- ▶ Belt widths up to 2.0m
- ▶ Agricultural, waste and general industrial



### Roller Chain - RC Series

- ▶ Medium duties
- ▶ Standard RC6 size
- ▶ Various pin, bush and bearing options
- ▶ Belt widths up to 4.0m
- ▶ Medium to heavy industrial, cement and mining



### Track Chain - D Series

- ▶ Heavy duty applications
- ▶ Standard D4 size
- ▶ D6 and D8 models available
- ▶ SALT chain, sealed for life
- ▶ Belt widths up to 4.0m
- ▶ Mining and heavy industrial

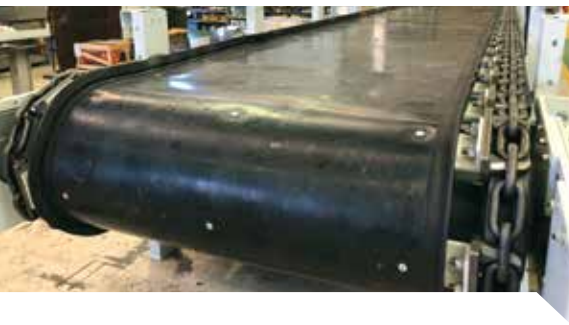

### CAPACITY CHART

STANDARD BELT WIDTH (mm)	EFFECTIVE SKIRTED WIDTH (mm)	NOMINAL CAPACITY MAXIMUM (m <sup>3</sup> /hr)
800	600	350
1200	1000	1000
1600	1400	1500
2000	1800	2000
2600	2400	3600
3200	3000	4800
4000	3800	8200

\*For confirmation on specific applications please consult Transmin direct.

# APPLICATIONS



METALLIC FILTER CAKE 50tph

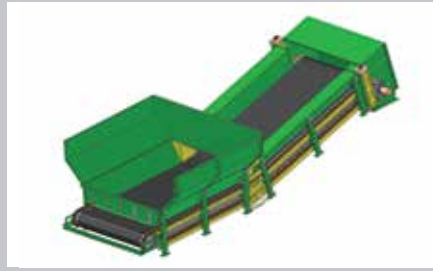

## Rear Tipping Truck Receiveal

Surface mounted for rear tipping trucks. Combined receiveal, storage and feeding. With or without weather enclosure. Eliminates the need for major excavations.

## Front End Loader Feed

Mounted on a simple pad, ideal for material recovery via wheel loader. Can be skid mounted for relocation. Caters for the largest buckets such as the WA1200.



IRON ORE TAILINGS 1500tph

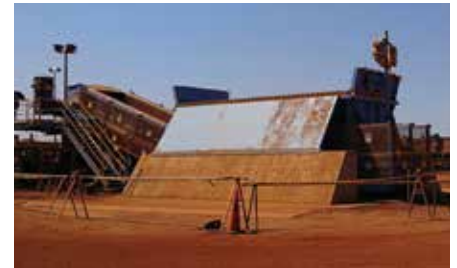

IRON ORE 2500tph

## Side-Tip Truck Receiveal

The side-tip truck application is perfectly suited for use by road-trains, making receiveal incredibly efficient. Multiple hoppers can be employed on a single machine. Photo shows one of twelve units installed at a multi-user facility in Western Australia.



VARIOUS ORES 1000tph

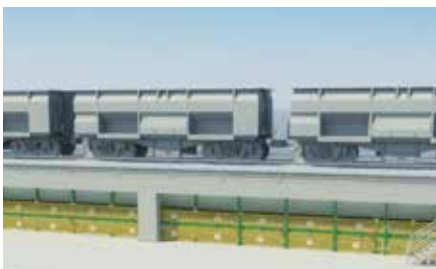

IRON ORE 2500tph

## Train Loading & Unloading

With its ultra-low profile, the LPF serves as a viable alternative to conventional feeders beneath rail lines and car dumpers at receiveal facilities in the port or processing plant.

Elevated discharge means wagons can be loaded directly from each side.

## Stockpile Reclaim

Ideal for use in the restricted space beneath stockpile, minimising civil costs. The LPF acts as a feeder and transfer conveyor in one. Stockpile tunnel reclaimers up to 42m long have been installed.



NICKEL REJECTS 1900tph

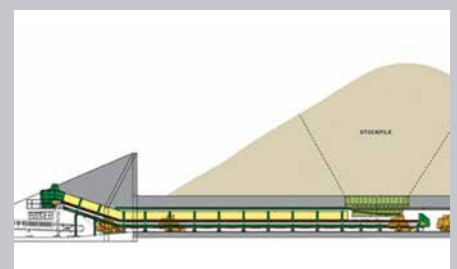

HARD ROCK 2000tph





COAL 3000tph

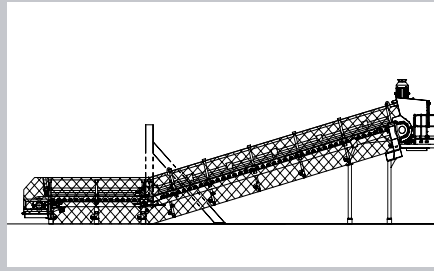

## Dozer Trap

Similar to stockpile reclaim applications, the LPF can also be configured as a dozer trap for simple stockpile management and easily relocated.

## Ore Bins & Screen Feeding

With a number of widths and load capacities available, the LPF is perfectly suited to sit beneath high capacity ore bins and silos.

Models up to 4.0m belt width are available to efficiently feed the widest screens used today.



SCREEN FEEDING IRON ORE 4000tph

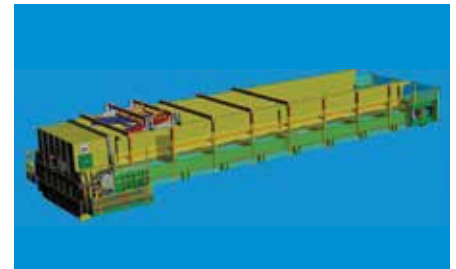

RED MUD TAILINGS

## Filter Press Discharge

Due to its low profile, the LPF can sit directly beneath filter presses to receive filter cakes and feed toward downstream plant equipment or vehicle receipt. The ability to have a horizontal hopper of a length to suit the application followed by an inclined section means the hopper capacity can be the maximised for best possible efficiency. The LPF can also be reversed for emergency dump of material.

## At the Crushing Station

With a number of widths and load capacities available, the LPF is perfectly suited to sit either above or below sizers and crushers. Optional features are available for use with very abrasive lumpy or sharp materials.



PRIMARY CRUSHED ORE 1500tph



GOLD ORE 2000tph



## Ejector Truck 'NEW'

A more efficient alternative to conventional ejector trays, the LPF was configured to convert ADT trays to a 'live bottom' design, eliminating the need to tip the tray for discharging. Also ideal for laying ballast or road base, whilst the truck moves forward.

## Case Study:

# IMPROVED STOCKPILE EXTRACTION WITH MINIMAL DOWNTIME AND CAPITAL WORKS COSTS



**Location:**  
Cadia Valley,  
New South Wales

**Operation Type:**  
Open Cut Gold Mine

### Issue on site:

Under the existing setup, the site was struggling to achieve sufficient extraction from the stockpile. The existing extraction method utilised conventional feeders submerged in conventional pre-cast concrete tunnels. Installing a secondary tunnel with conventional belt or apron feeder extraction and associated chutes onto a collector conveyor belt would prove expensive, not least due to the height requirement (5m plus), and would take the plant out of production for excessively long periods. One alternative would be to use a front end loader to supplement the extraction, but this too would prove both time and labour intensive.

### The Solution:

Transmin's solution, was to utilise the Low Profile Feeder (LPF) with its low 1<m installed height advantage, and ability to incline within a single machine. The LPF would be located in an additional precast concrete tunnel submerged under the stockpile, with an extraction slot approximately 7m long.

The LPF would act as both feeder and conveyor - extracting and carrying ore from the stockpile simultaneously on the same machine for approximately 40m towards an inclined section, where it would be deposited directly onto a conventional conveyor.

Thanks to the LPF's ultra-low profile, the height requirement of the pre-cast tunnel sections could be brought down, and the need for additional chute-work eliminated thanks to the built-in incline section. The end result would be a substantial reduction in civil-works.

This in turn meant installation could be completed with minimum disruption to stockpile operations. A culvert would be dug-out using excavators and the new pre-cast concrete tunnels dropped into place, allowing the stockpile to be quickly reformed and put back into full service.

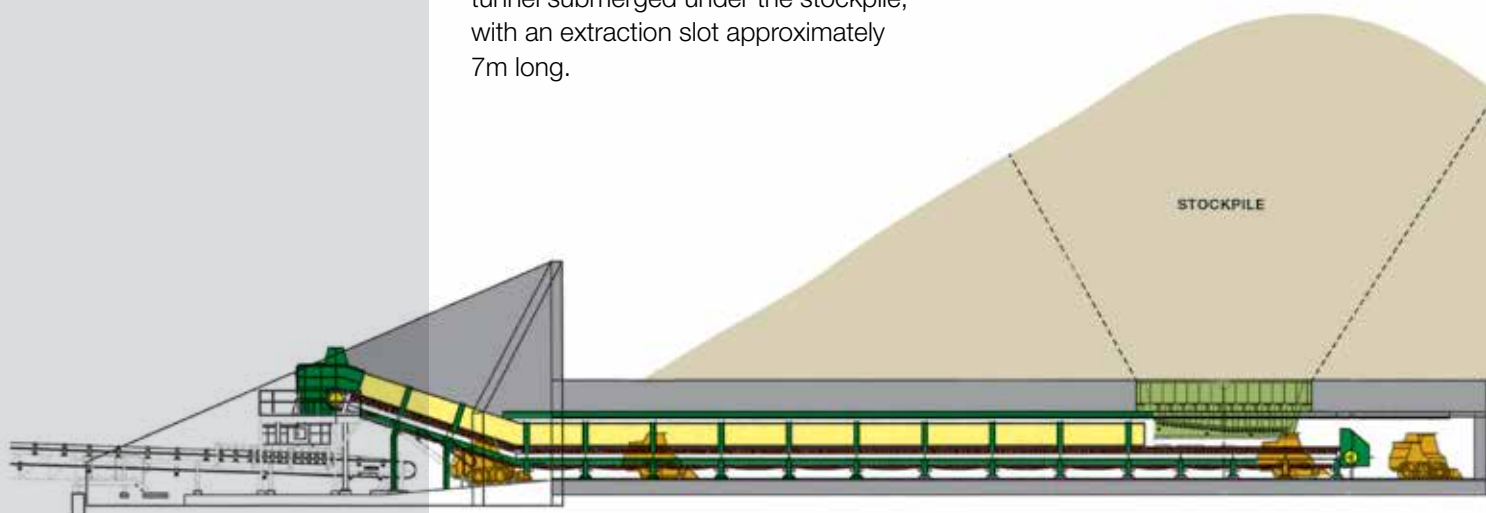



## Case Study:

# LOW PROFILE FEEDER (LPF)<sup>TM</sup> 'RECLAIM HOPPER' FOR IRON ORE TAILINGS



**Location:**  
220km SE of Geraldton,  
Western Australia

**Operation Type:**  
Iron Ore/Magnetite Mine

### LPF<sup>TM</sup> Specifications:

- ▶ **Heavy-duty D4 chain**
- ▶ **1.8m wide belt**  
Reinforced with steel slats
- ▶ **1500 tph**
- ▶ **Belt speed 0.25m/second**
- ▶ **35m<sup>3</sup> hopper**  
For front-end-loader
- ▶ **75kw electric motor**
- ▶ **Total weight approx. 40 tonnes**

### Scope of Project:

Transmin's client, a global EPC servicing the mining and cement industries, were looking for a cost-effective way to transfer stockpiled iron ore tailings from a series of filter presses to an overland conveyor at a newly established iron ore and magnetite mine in Mid-Western Australia.

The EPC had been hired by the site contractor and operator, to come up with a solution to the problem and decided that the most efficient way to do this was to use a low profile 'Reclaim Hopper' that could be fed iron ore tailings using a front end loader.

This would enable significant savings to be made by eliminating the need for multiple conveyors and transfer points, which require a larger capital outlay than a single CAT 992k loader.

The system also needed to be able to transfer 1500 tonnes of iron ore tailings per hour from the reclaim stockpile to the overland conveyor in order to meet the production requirements of the site's owner.

### The Solution:

Transmin's Low Profile Feeder (LPF)<sup>TM</sup> Reclaimer Hopper was the perfect choice for their situation because it fills the role of both feeder and conveyor, and allows for receipt, storage and feeding to be done with the one machine, saving on additional capital expenditure.

It is also designed to have a bulk-loading hopper fitted to the frame, so it can be fed using front-end-loaders and other bucket machinery, which was one of the project's primary requirements.

Management at the EPC were also impressed with the various models Transmin had available, and the fact they can be customised with many additional features and options, including a large range of capacities and belt sizes, and the unique ability to change direction from horizontal to inclined using a bend transition without the need for additional machines or transfer points.





**HEAD OFFICE**

**Western Australia**

**Local Call:** 1300 127 091

**International Call:** +61 (0) 8 9270 8555

**Email:** wasales@transmin.com.au

**Address:** 33-37 Denninup Way Malaga  
Perth, Western Australia, 6090

**Queensland & Northern Territory**

**Local Call:** 1300 800 609

**International Call:** +61 (0) 7 3736 3340

**Email:** qldsales@transmin.com.au

**Address:** 76 Dulacca Street  
Acacia Ridge, Brisbane  
Queensland, 4110

**INTERNATIONAL OFFICES**

**South America**

**Email:** sales.sa@transmin.com.au

**North America**

**Email:** sales.ca@transmin.com.au

**India**

**Email:** sales.in@transmin.in

[www.transmin.com.au](http://www.transmin.com.au)



Committed to being a  
world class supplier and service provider  
recognised for integrity pure innovation

